

ADEMS®

アデムス

DIGITAL IMAGING SOLUTIONS

www.adems.co.in
ademsdigital@gmail.com



DISPLAY CENTRE:

No.76, 1st Floor, Quality Tower,
Ellis Road,
Annasalai, Chennai - 600 002.

ABOUT:

OUR TEAM ADEMS DIGITAL IMAGING SOLUTIONS HAS LAUNCHED A NEW PRODUCT ON THE MARKET WHICH IS ECO FRIENDLY AND COST EFFECTIVE. IN TERMS IT'S A SUBSTITUTE FOR PAPERS.

It's Made from Polyester Resin Coated Aluminium

Panels

Our metal prints are in a class of their own, With Extraordinary clarity and archival quality

SIZE & THICKNESS:

Customized size and thickness from 0.2 to 1 mm

COLOURS:

- * Silver (Brushed / Matt)
- * White (Gloss / Matt)
- * Gold (Brushed / Matt)

FEATURES OF METAL PRINT:

- Exceptional Detail
- Archival Quality
- Personalized Presentation
- Flame Resistant
- Chemical Resistant
- Long lasting &
- Rust Proof

Present your products in a variety of exciting and creative ways to complement your unique aesthetic.

Following image samples for ideas and the work we do:

INDUSTRIAL NAME PLATES & TAGS:

Resin coated aluminium tags

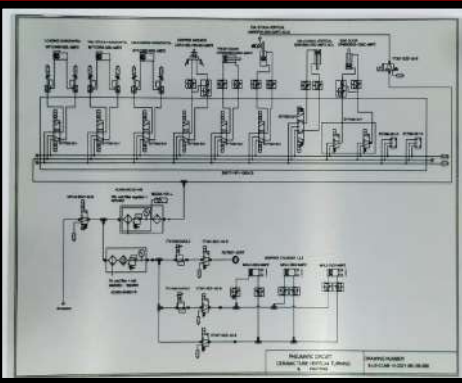
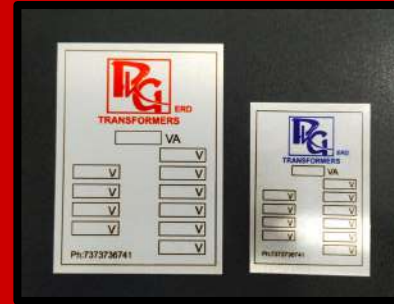
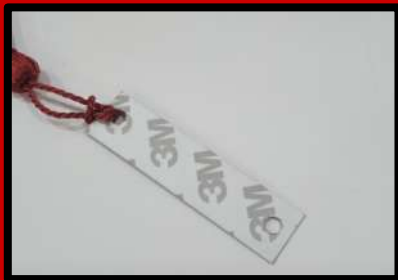

Industrial name tags



CURVED ALUMINIUM NAME PLATES:



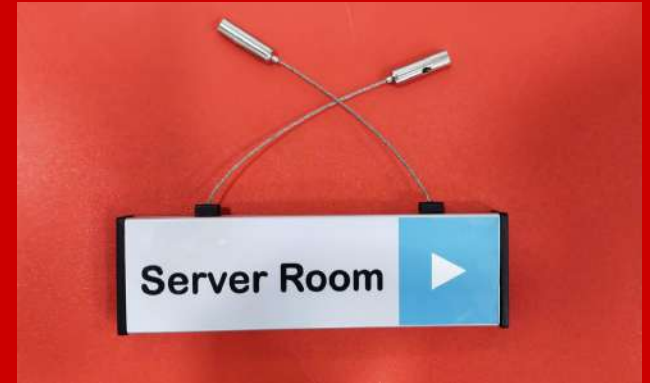

SOME OF OUR WORK ON HOSPITAL AND CHENNAI METRO STATIONS



CORPORATE OFFICE INTERIOR INFORMATION BOARD & METRO STATION GUIDE BOARD

EXECUTIVE BUSINESS CARDS:

P. Mohanraj, B.E.,
Chairman & Managing Director

Diamond Engineering (Chennai) Pvt. Ltd.
Anything in Steel

REGISTERED OFFICE
#501, Vandalur - Kelambakkam Main Road,
Mambakkam, Chennai - 600 127.
Phone : +91 - 44 - 2747 9149 | Mobile : +91 - 98400 97123
E-Mail : pmr@decpl.com | Website : www.decpl.com

P. Mohanraj, B.E.,
Chairman & Managing Director

Diamond Engineering (Chennai) Pvt. Ltd.
Anything in Steel

REGISTERED OFFICE
#501, Vandalur - Kelambakkam Main Road,
Mambakkam, Chennai - 600 127.
Phone : +91 - 44 - 2747 9149 | Mobile : +91 - 98400 97123
E-Mail : pmr@decpl.com | Website : www.decpl.com

P. Mohanraj, B.E.,
Chairman & Managing Director

Diamond Engineering (Chennai) Pvt. Ltd.
Anything in Steel

REGISTERED OFFICE
#501, Vandalur - Kelambakkam Main Road,
Mambakkam, Chennai - 600 127.
Phone : +91 - 44 - 2747 9149 | Mobile : +91 - 98400 97123
E-Mail : pmr@decpl.com | Website : www.decpl.com

DIAMOND GROUP
Anything in Steel
ISO 9001 - 2015 Certified Company

Dr. Balan
International Investment Partner
+91 73050 09991
+91 75388 50574

Diamond Engineering (Chennai) Pvt. Ltd.
#501, Vandalur - Kelambakkam Main Road,
Mambakkam, Chennai - 600 127
Tamilnadu, INDIA.
Ph: +91 44 2747 9149, 2747 9152
Fax: +91 44 2747 9151
Email : drb.investments@decpl.com
www.decpl.com

QATAR AIRWAYS
القطرية

e paper

EXCELMARK BUSINESS PAPERS PRIVATE LIMITED

N. VIJAYAKUMAR
MANAGING DIRECTOR

No. 76, Ellis Road,
"Quality Towers", First Floor,
Chennai-600002, INDIA
+91 9840034705
6374609561
excelmarktrading@gmail.com
ademsdigital@gmail.com
www.adems.co.in

ADEMS®
デジタルメディア
DIGITAL IMAGING MEDIA

Polyester Resin Coated Aluminium Sign Boards/Labels/Name plates/Tags

ADEMS®
デジタルメディア

MORE METAL EXECUTIVE BUSINESS CARDS



BADGES & FRIDGE MAGNETS:



ROUND FRIDGE MAGNETS/ BADGES & KEY CHAIN



Adems Square metal Tea coasters:



CONSTRUCTION & INDUSTRY SIGNAGES:

MINCO MINNEAPOLIS, MN U.S.A.

ASSEMBLY / ASSEMBLAGE
COND THR: _____ DATE #: _____

Ta: -50 TO 55 C Tprocess: -50 to 260 c
KEMA 03 ATEX 2389 X Umax: 45 VDC Imax: 30 mA
Pmax: 1.35 W

DO NOT OPEN WHEN EXPLOSIVE ATMOSPHERE IS PRESENT
0344 NE PAS OUVRIR EN PRESENCE D'ENVIRONNEMENT EXPLOSIF

VIN NUMBER
1ABCD23EFGH456789

VIN NUMBER
1ABCD23EFGH456789

VIN NUMBER
1ABCD23EFGH456789

MINCO MINNEAPOLIS, MN U.S.A.

ASSEMBLY / ASSEMBLAGE
COND THR: _____ DATE #: _____

Ta: -50 TO 55 C Tprocess: -50 to 260 c
KEMA 03 ATEX 2389 X Umax: 45 VDC Imax: 30 mA
Pmax: 1.35 W

DO NOT OPEN WHEN EXPLOSIVE ATMOSPHERE IS PRESENT
0344 NE PAS OUVRIR EN PRESENCE D'ENVIRONNEMENT EXPLOSIF

BOND MOTOR CO LTD
MADE IN JAPAN
CRUISER 2002 MODEL

BOND MOTOR CO LTD
MADE IN JAPAN
CRUISER 2002 MODEL

BOND MOTOR CO LTD
MADE IN JAPAN
CRUISER 2002 MODEL

BBS01B 36V 250W
QC Pass **CE**
MADE IN INDIA

BBS01B 36V 250W
QC Pass **CE**
MADE IN INDIA

BBS01B 36V 250W
QC Pass **CE**
MADE IN INDIA

AIR CONDITIONER NISSAN

REFRIGERANT	COMPRESSOR LUBRICANT
TYPE: RFC 134a (R134a) AMOUNT: 0.36+ 0.25 kg (1.10 + 0.855 lbs)	NISSAN LUBRICANTS OIL TYPE CH-PS (RL134a) AMOUNT: 150 ML (5.03 OZ.)

CAUTION
PRECAUTION
- REFRIGERANT UNDER HIGH PRESSURE.
- SYSTEM TO BE SERVICED BY QUALIFIED PERSONNEL.
- IMPROPER SERVICE METHODS MAY CAUSE PERSONAL INJURY.
- CONSULT SERVICE MANUAL.
- THIS AIR CONDITIONER SYSTEM COMPLIES WITH SAE J-639.
Nissan Motor Corporation in USA, Canton, CA

AIR CONDITIONER NISSAN

REFRIGERANT	COMPRESSOR LUBRICANT
TYPE: RFC 134a (R134a) AMOUNT: 0.36+ 0.25 kg (1.10 + 0.855 lbs)	NISSAN LUBRICANTS OIL TYPE CH-PS (RL134a) AMOUNT: 150 ML (5.03 OZ.)

CAUTION
PRECAUTION
- REFRIGERANT UNDER HIGH PRESSURE.
- SYSTEM TO BE SERVICED BY QUALIFIED PERSONNEL.
- IMPROPER SERVICE METHODS MAY CAUSE PERSONAL INJURY.
- CONSULT SERVICE MANUAL.
- THIS AIR CONDITIONER SYSTEM COMPLIES WITH SAE J-639.
Nissan Motor Corporation in USA, Canton, CA

AIR CONDITIONER NISSAN

REFRIGERANT	COMPRESSOR LUBRICANT
TYPE: RFC 134a (R134a) AMOUNT: 0.36+ 0.25 kg (1.10 + 0.855 lbs)	NISSAN LUBRICANTS OIL TYPE CH-PS (RL134a) AMOUNT: 150 ML (5.03 OZ.)

CAUTION
PRECAUTION
- REFRIGERANT UNDER HIGH PRESSURE.
- SYSTEM TO BE SERVICED BY QUALIFIED PERSONNEL.
- IMPROPER SERVICE METHODS MAY CAUSE PERSONAL INJURY.
- CONSULT SERVICE MANUAL.
- THIS AIR CONDITIONER SYSTEM COMPLIES WITH SAE J-639.
Nissan Motor Corporation in USA, Canton, CA

AIR CONDITIONER NISSAN

REFRIGERANT	COMPRESSOR LUBRICANT
TYPE: RFC 134a (R134a) AMOUNT: 0.36+ 0.25 kg (1.10 + 0.855 lbs)	NISSAN LUBRICANTS OIL TYPE CH-PS (RL134a) AMOUNT: 150 ML (5.03 OZ.)

CAUTION
PRECAUTION
- REFRIGERANT UNDER HIGH PRESSURE.
- SYSTEM TO BE SERVICED BY QUALIFIED PERSONNEL.
- IMPROPER SERVICE METHODS MAY CAUSE PERSONAL INJURY.
- CONSULT SERVICE MANUAL.
- THIS AIR CONDITIONER SYSTEM COMPLIES WITH SAE J-639.
Nissan Motor Corporation in USA, Canton, CA

VINAYAGA SHUTTERS

PLOT NO. 879, 880 CHDA IRON & STEEL MARKET, SATHANGADU, MANALI, CHENNAI - 68

PHONE: 9551509848 / 9551599903

EMAIL: SERVICE@VINAYAGA.COM / CHENNAI@VINAYAGA.COM

WEBSITE: WWW.VINAYAGASHUTTERS.COM

S. NO. _____

MODEL _____

MFG DATE _____

VINAYAGA SHUTTERS

PLOT NO. 879, 880 CHDA IRON & STEEL MARKET, SATHANGADU, MANALI, CHENNAI - 68

PHONE: 9551509848 / 9551599903

EMAIL: SERVICE@VINAYAGA.COM / CHENNAI@VINAYAGA.COM

WEBSITE: WWW.VINAYAGASHUTTERS.COM

S. NO. _____

MODEL _____

MFG DATE _____

VINAYAGA SHUTTERS

PLOT NO. 879, 880 CHDA IRON & STEEL MARKET, SATHANGADU, MANALI, CHENNAI - 68

PHONE: 9551509848 / 9551599903

EMAIL: SERVICE@VINAYAGA.COM / CHENNAI@VINAYAGA.COM

WEBSITE: WWW.VINAYAGASHUTTERS.COM

S. NO. _____

MODEL _____

MFG DATE _____

VINAYAGA SHUTTERS **VINAYAGA SHUTTERS** **VINAYAGA SHUTTERS** **VINAYAGA SHUTTERS**



ADEMS[®]
アデムス

PHOTOGRAPHY & INTERIOR DISPLAY WORKS:



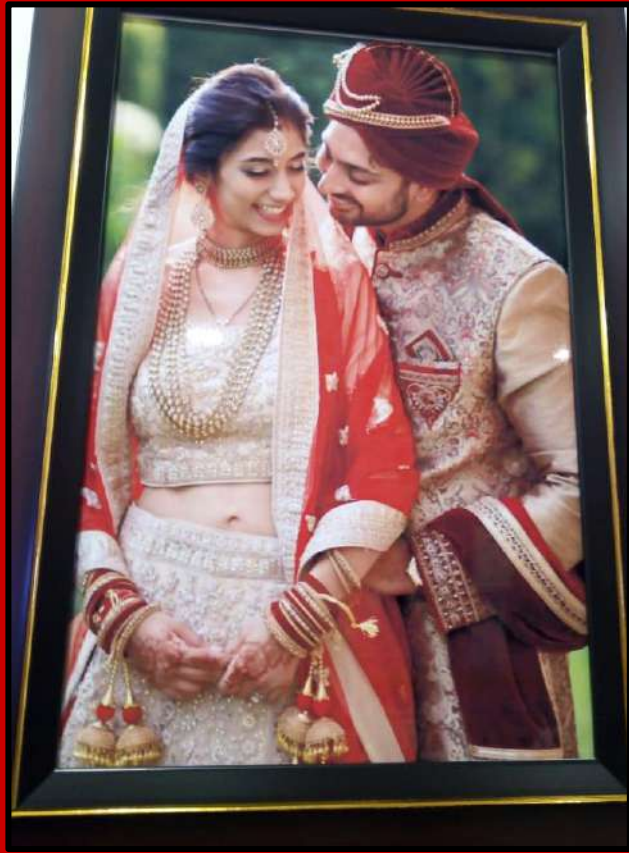

EXTERIOR NAME PLATE AND SIGNAGES:



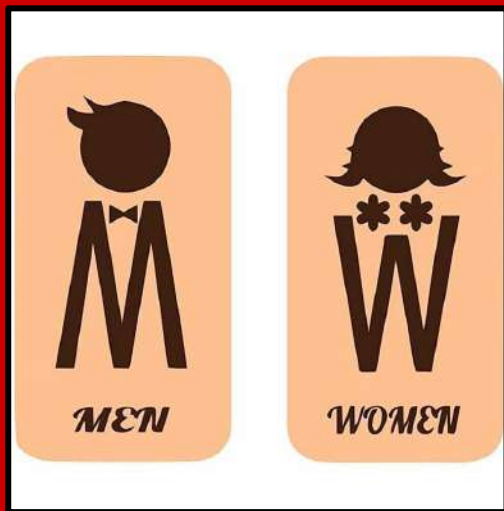

EXTERIOR SIGNAGES:



R&C
அரசு அங்கீகரிக்கப்பட்டது

Govt. of India Regn. No.: TN-02-0092351
GSTIN : 33AAYFR6493A1ZT

சுற்றுச்சூழல் ஆய்வகம்
R&C ENVIRONMENT LAB
Reliable & Competent
ENVIRONMENTAL ENGINEERING LABORATORY DIVISION
உலக சுற்றுச்சூழல் சேவைகள்
GLOBAL ENVIRONMENTAL SERVICES

1/61, KULAKARAI STREET, VOC NAGAR MAIN ROAD, ADAYALAMPET,
MADURAVOYAL, CHENNAI - 600 095, TAMILNADU, INDIA.

Phone: 044 - 2653 0144 | +91 - 90430 75949 | 94445 85405
Website: <https://www.rcenvirolab.com> | e-mail: rcenvirolab@gmail.com



RESIDENCE NAME PLATES:



DEVOTIONAL PHOTOGRAPHY FOR RESIDENCE AND SHOPS:

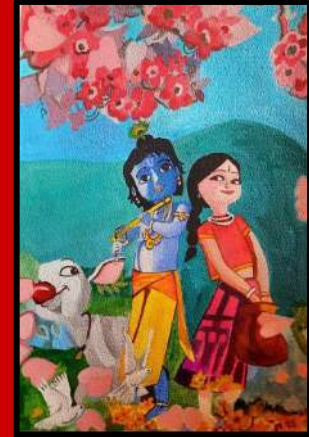

CALENDARS/ BADGES & TROPHYS:



1:1-2022

EXCELMARK BUSINESS PAPERS PRIVATE LIMITED
 No. 68, V.D. Shank Nagar,
 Madhavaram, Chennai - 600030.
 Pkt. #1 0649034705 0840834705
 E-mail: excelm@excelm.com

ADEMS DIGITAL IMAGING SOLUTIONS
 No. 79, First Floor, Quality Towers,
 Elite Road, Mount Road, Chennai - 600002.
 Pkt. #1 9849034705 0374965961
 Email: ademdigital@gmail.com

Polyester Resin Coated Aluminium
 LED Sign Boards, Labels,
 Badges, Name Plates,
 Tags, Stickers and Signages.



COMMANDER'S COURT

Tagged on Oct 2021, Government
 Chennai-70, +91 9566115544
 contact@covensantrousseaux.com

ADEMS © 2021



Don't STOP LEARNING

Veranda RACE



NEERAJ JAIN
Vice-Principal

HINDUJA PRAKASH PATEL
Service Manager

PIZZA HUT DAVID ROSS
RESTAURANT MANAGER

Domino's Pizza Ashok Kumar
Sales Manager

DHL
Ronald Geoffs
Goods in Supervisor



SARAVANAS JANGIRI
HOTEL ஜாங்கிரி
(250g)
Rs. 90/-

NURSING SUPERVISOR

NURSING SUPERVISOR

NURSING SUPERVISOR

NURSING SUPERVISOR

MATRON

ADEMS
アデムス

SAFETY SIGNAGES:



ALUMINIUM BRAND METAL
TAGS FOR OUR CLIENTS:

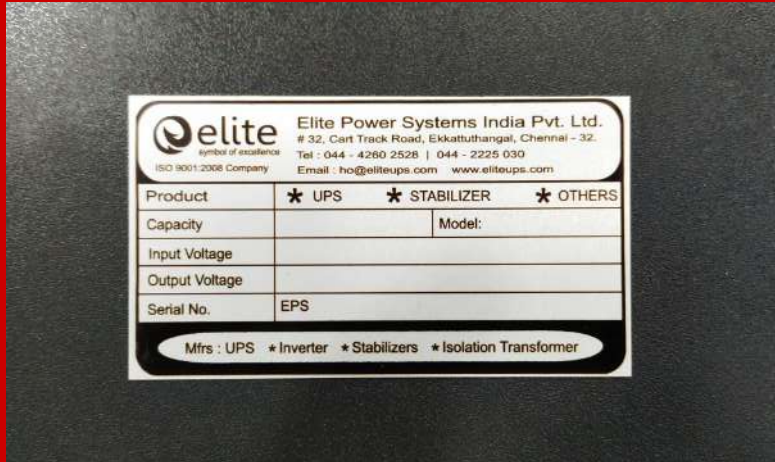

Our Other Works:



LED Clip - on Frame



LED Crystal Frame



LED Lollipop Sign Board

LED SIGN BOARDS:



ALL TYPES OF Q - MANAGERS:



Elite Q - Manager

Double tape Q - Manager



Standard Q - Manager



Fabric Barrier Q - Manager

OUR OTHER PRODUCTS FOR SALE



3M - TAPE - 1" & ½"



ADHESIVE GLUE